

N2GEN-FLEX SERIES

O&M MANUAL



Table of Contents

South-Tek Systems	3
1. General Function and System Overview	4
2. Safety/Warnings	4
3. Technical Specifications	4
a. Electrical Input	4
b. Ambient Temperature and Air Requirements	4
c. Performance Tables	5
4. Installation/Use	6
a. Unpacking.....	6
b. Install	6
c. Operation.....	6
5. Programming.....	7
a. Home Screen	7
b. Status Screen.....	7
c. Maintenance Screen.....	7
d. Alarm Record Screen.....	8
e. Historical Curve Screen	8
f. Historical Data Screen.....	8
g. User Settings Screens.....	9
First User Settings Screen	9
Second User Settings Screen	10
Third User Settings Screen	11
h. N2 Process Screen	11
i. Test Screens	11
6. Maintenance	12
7. Troubleshooting/FAQ	12
8. Detail Drawings	13
9. Disclaimer and Copyright.....	15
Disclaimer	15
Copyright	15
Trademarks.....	15

South-Tek Systems

Leading Designer and Manufacturer of Nitrogen Generators

At South-Tek Systems, we design, engineer, and manufacture on-demand Nitrogen generation equipment that delivers the exact purity and flow rate applications require. Our team is committed to providing innovative, highly engineered, high-quality, and cost-effective Nitrogen Generator systems to meet our customers' requirements.

Along with superior service, our team takes the time to better understand each particular application, allowing us to provide perfectly tailored solutions that continually surpass our customer's expectations.

With a commitment to ongoing research and development, South-Tek has created patented and patent-pending technology that maximizes the longevity and efficiency of Nitrogen Generation Systems. South-Tek not only provides the best customer support and user experience in the industry, we're also the most innovative.



1. General Function and System Overview

The N2GEN-FLEX series of pressure swing adsorption (PSA) nitrogen generators can provide nitrogen at 95-99.999% purity over a wide range of flow rates. These systems consist of multiple sieve beds with manifolds, a control cabinet, and (depending on system size) a nitrogen tank mounted on a skid. These systems allow nitrogen to be generated on demand, eliminating the need for a long-term contract to obtain liquid nitrogen.

The N2GEN-FLEX systems were designed to provide nitrogen with minimal air input, especially at higher purities (see Section 3.c.). The N2GEN-FLEX systems enter a “Standby” phase during periods of low nitrogen use, preventing unnecessary air consumption. The N2GEN-FLEX systems have a built-in feature for exhausting low purity gas in the storage tank to the atmosphere if it doesn’t meet the input specification.

2. Safety/Warnings

This product is intended for installation and use by trained personnel. Improper installation or operation can lead to injury or damage to equipment. Read the entirety of this manual prior to installation to ensure appropriate use.

Nitrogen is an inert gas comprising 78% of the air in our atmosphere. Concentrated nitrogen is odorless and though not poisonous may cause asphyxiation. Ensure the unit is in a room with adequate ventilation.

3. Technical Specifications

a. Electrical Input

Electrical Requirements	
Power	100-240 VAC, 50/60 Hz, Single Phase, 2.1A Max

Electrical connections to the N2GEN-FLEX nitrogen generator shall be made by an electrician authorized to work in the user’s state/region.

b. Ambient Temperature and Air Requirements

The N2GEN-FLEX nitrogen generators are rated to operate in 40-90°F (4.44-32.2°C) ambient temperatures. Performance derating will be applied for temperatures above 90°F (32.2°C). Air supplied to the nitrogen generator must comply with ISO 8573-1, 1.4.1.

c. Performance Tables

N2 Flow (SCFH) at 79°F and 100 PSIG Air Inlet							
N2 Purity (%)	95	97	99	99.5	99.9	99.99	99.999
N2GEN-FLEX-2TS	374	296	218	190	137	95	63
N2GEN-FLEX-4TS	670	558	396	340	248	184	140
N2GEN-FLEX-6TS	904	698	525	435	329	234	179
N2GEN-FLEX-8TS	1172	935	698	558	432	312	251
N2GEN-FLEX-10S	1569	1283	1004	893	670	419	346
N2GEN-FLEX-12S	1758	1418	1018	949	725	452	374
N2GEN-FLEX-14S	2075	1722	1364	1119	867	577	438

Air/N2							
N2 Purity (%)	95	97	99	99.5	99.9	99.99	99.999
N2GEN-FLEX-2TS	2.1	2.4	2.7	2.9	3.4	4.3	5.7
N2GEN-FLEX-4TS	2.0	2.2	2.7	2.9	3.5	4.3	5.4
N2GEN-FLEX-6TS	2.0	2.3	2.6	2.9	3.5	4.4	5.5
N2GEN-FLEX-8TS	1.9	2.1	2.5	2.8	3.4	4.2	5.0
N2GEN-FLEX-10S	2.0	2.2	2.5	2.6	3.2	4.4	5.1
N2GEN-FLEX-12S	1.9	2.2	2.6	3.0	3.2	4.5	5.1
N2GEN-FLEX-14S	2.0	2.2	2.5	2.8	3.2	4.5	5.5

4. Installation/Use

a. Unpacking

The nitrogen generation system will arrive bolted inside of a wooden crate. Remove the door panel at the end of the assembly and remove the four bolts from each corner of the skid. A forklift or similar equipment should be used to remove the assembly from the crate.

Check for signs of damage out of the crate and report any findings to the carrier or South-Tek Systems' service department. If there is significant damage to any shipping materials, it should be noted on the bill of lading before signing.

b. Install

A certified electrician should review all electrical connections prior to system operation. Bolt holes are included on the bottom of the skid, though floor mounting is optional. The installation site should adhere to the environmental specifications listed in Section 3.b., be no more than 5° off level, and be reasonably clear of dust and debris. At least three feet of clearance must be provided on all sides of the skid for maintenance purposes.

c. Operation

****Prior to operation, contact South-Tek Systems' service department to schedule virtual training or on-site commissioning.***

The system can be turned on or off by pressing a button on the "Status" screen (see Section 5.b.). To start the system, ensure that the E-Stop is not engaged, and that the PLC screen is active. After turning the system off by using the button on the "Status" screen, the user must wait until "Shutdown Delay" (see Section 5.g.) is no longer displayed before turning the system on again.

The value of "Purity Discharge Rate" (see Section 5.g.) is the minimum purity that must be met in order for nitrogen to flow to the customer's application. Tank contents will be exhausted into the atmosphere if it does not meet this value. During system operation, if the output nitrogen pressure exceeds the value of "Stopping pressure" for a duration longer than "High Pressure Shutdown Delay", then the system will go into Standby until the output nitrogen pressure reaches the value of "Starting pressure", which will turn the system on again (see Section 5.g. for the location of these inputs).

Refer to the specification sheet in your attached file packet to observe the operating conditions of the system. The system will arrive tuned to perform as specified; do not adjust any valves, regulators, or PLC settings without consulting South-Tek Systems.

5. Programming

a. Home Screen

The language may be selected from the “Home” screen. The language options are English (default), Spanish, and French. Pressing “Continue” opens the “Status” screen.

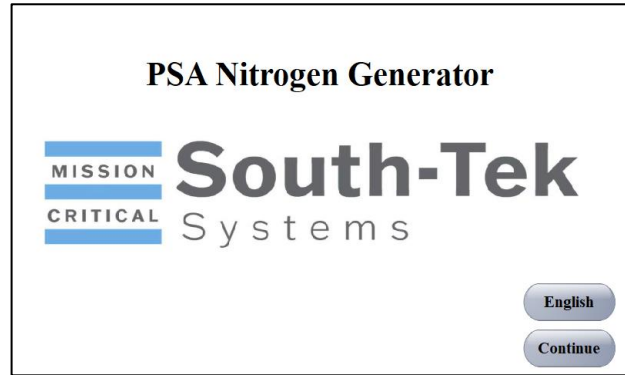

b. Status Screen

The “Status” screen shows the current output nitrogen pressure, purity, and flow rate. The system can be turned on or off on this screen.

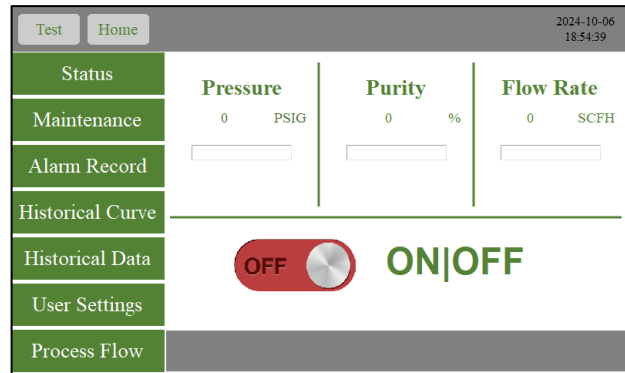

c. Maintenance Screen

Pressing the “Maintenance” button shows the total amount of run hours, the run time before the next scheduled maintenance, and how long the filters have been in use. The time for next scheduled maintenance and/or filter replacement will be reset by authorized personnel after service has been performed

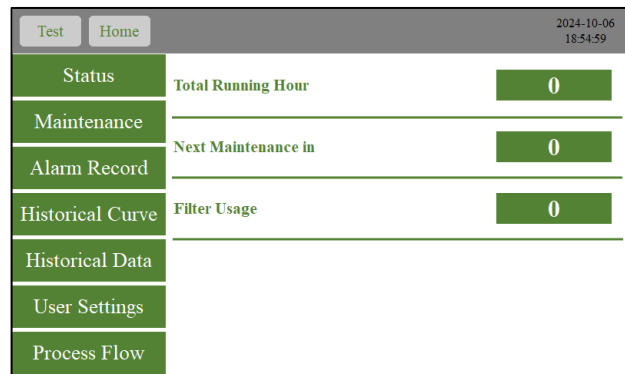

d. Alarm Record Screen

Pressing the “Alarm Record” button shows the date and time of past alarms. The user can reset the alarms on this screen. Maintenance alarms should only be reset after service has been performed.

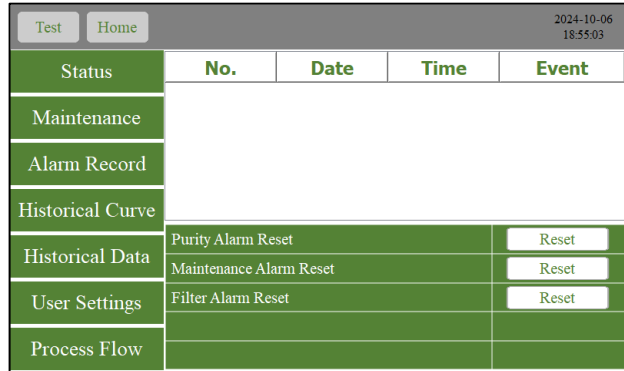

Status	No.	Date	Time	Event
Maintenance				
Alarm Record				
Historical Curve				
Historical Data				Purity Alarm Reset <input type="button" value="Reset"/>
User Settings				Maintenance Alarm Reset <input type="button" value="Reset"/>
Process Flow				Filter Alarm Reset <input type="button" value="Reset"/>

e. Historical Curve Screen

Pressing the “Historical Curve” button shows graphs of purity, flow rate, and pressure.

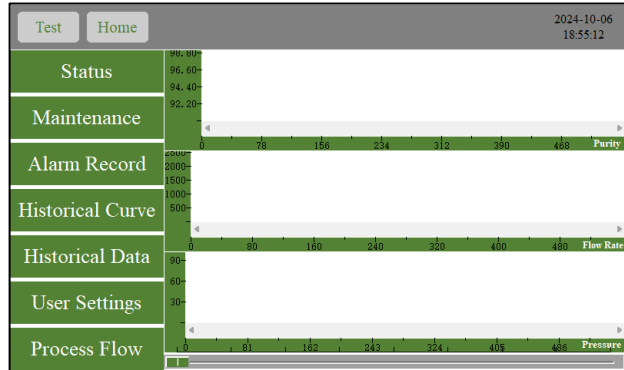

f. Historical Data Screen

Pressing the “Historical Data” button shows past data for purity, flow rate, and pressure. The user can set the data storage interval (in seconds) at the bottom of this screen.

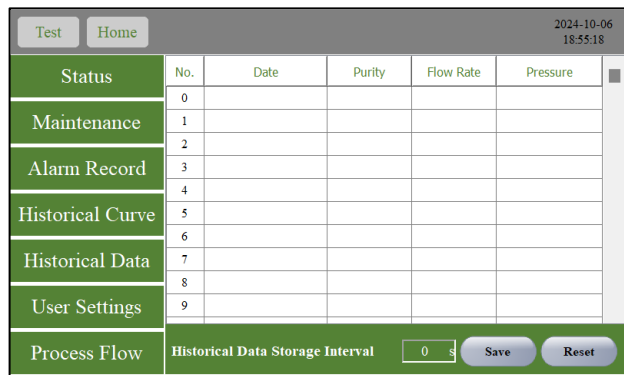

Status	No.	Date	Purity	Flow Rate	Pressure
Maintenance	0				
Alarm Record	1				
Historical Curve	2				
Historical Data	3				
User Settings	4				
Process Flow	5				
	6				
	7				
	8				
	9				

Historical Data Storage Interval:

g. User Settings Screens

A prompt to enter a user password will appear when the “User Settings” button is pressed. **The user password is 2588.**

First User Settings Screen

<input type="button" value="Test"/> <input type="button" value="Home"/>		2024-10-06 18:55:28
Status		<input type="button" value="Next"/>
Maintenance	Communication Address	<input type="text" value="0"/>
	Shutdown Delay	<input type="text" value="0"/> s
Alarm Record	Low Pressure Alarm	<input type="text" value="0"/> PSIG
	Starting pressure	<input type="text" value="0"/> PSIG
Historical Curve	Stopping pressure	<input type="text" value="0"/> PSIG
	Starting flowrate	<input type="text" value="0"/> SCFH
Historical Data	Stopping flowrate	<input type="text" value="0"/> SCFH
	High Pressure Shutdown Delay	<input type="text" value="0"/> s
User Settings	Flow Standby Mode Activation Time	<input type="text" value="0"/> s
	Process Flow	

Communication Address: Unused for regular operation. The user should never change this input.

Shutdown Delay: An amount of time that must pass before the system can be turned on after shutdown. This prevents the system from being turned on and off rapidly, avoiding potential component failures.

Low Pressure Alarm: A low pressure alarm will trigger if the inlet pressure is below this input value.

Starting Pressure: The system will resume regular operation if the pressure in the nitrogen tank decreases to this input value after the system has been in standby mode.

Stop Pressure: The system will enter standby mode when the pressure in the nitrogen tank reaches this input value.

Starting Flowrate: The system will resume regular operation if the nitrogen flow rate reaches this input value after the system has been in standby mode.

Stopping Flowrate: The system will enter standby mode when the flow rate reaches this input value.

High Pressure Shutdown Delay: The system will not go into standby mode until the pressure in the nitrogen tank exceeds the “Stopping Pressure” setpoint for this input amount of time.

Flow Standby Mode Activation Time: The system will not go into standby mode until the nitrogen flow rate exceeds the “Stopping Flowrate” setpoint for this input amount of time.

Note: Standby mode can be controlled by either the nitrogen tank pressure or the nitrogen flow rate, but not by both at the same time. If standby mode is to be controlled by the nitrogen tank pressure, then “Starting Flowrate”, “Stopping Flowrate”, and “Flow Standby Mode Activation Time” must all be set to 0. Alternatively, if standby mode is to be controlled by the nitrogen flow rate, then “Starting Pressure”, “Stopping Pressure”, and “High Pressure Shutdown Delay” must all be set to 0.

Second User Settings Screen

Test Home 2024-10-06 18:55:34	
Status	<div style="text-align: right;"> Previous Next </div>
Maintenance	Purity Alarm Start Time <input type="text" value="0"/> min
	Purity Alarm Stop Time <input type="text" value="0"/> min
Alarm Record	Purity Alarm Setting <input type="text" value="0.000"/> %
	Purity Discharge Rate <input type="text" value="0.000"/> %
Historical Curve	Serial Port 1 Format <input type="text" value="8N1-N"/> ▼
	Serial Port 1 Baud Rate <input type="text" value="9600"/> ▼
Historical Data	Maintenance Setting <input type="text" value="0"/> h
	Maintenance Reminder <input type="text" value="0"/> h
User Settings	Filter Maintenance Setting <input type="text" value="0"/> h
Process Flow	

Purity Alarm Start Time: A purity alarm will trigger if the purity does not meet the requirement within the input amount of time.

Purity Alarm Stop Time: If a purity alarm is not resolved within the input amount of time, then the system will shut down.

Purity Alarm Setting: A purity alarm will trigger if the purity is below this input value.

Purity Discharge Rate: Nitrogen will be exhausted into the atmosphere if the purity is below this input value.

Serial Port 1 Format: Unused for regular operation. The user should never change this input.

Serial Port 1 Baud Rate: Unused for regular operation. The user should never change this input.

Maintenance Setting: An input for the number of system running hours before the next scheduled maintenance.

Maintenance Reminder: An input for the number of system running hours before a maintenance reminder is displayed.

Filter Maintenance Setting: An input for the number of system running hours before the filters will be replaced.

Third User Settings Screen

The third screen shows the current date and time, which can be adjusted. It also has an input for the Start/Stop Mode, which toggles between “Local” and “Remote”, but the user should never change this input.

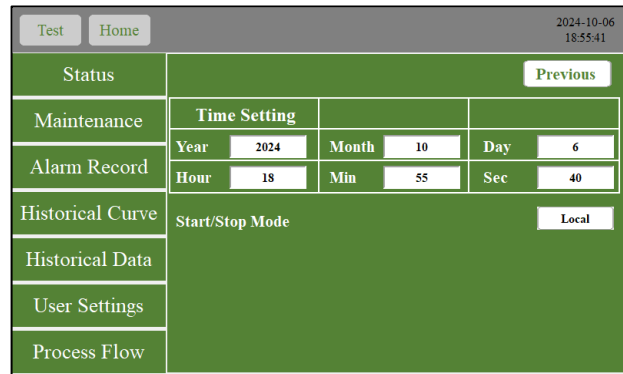

h. N2 Process Screen

Pressing the “N2 Process” button shows what valves are open at any given time, as well as gas flow paths through the system.

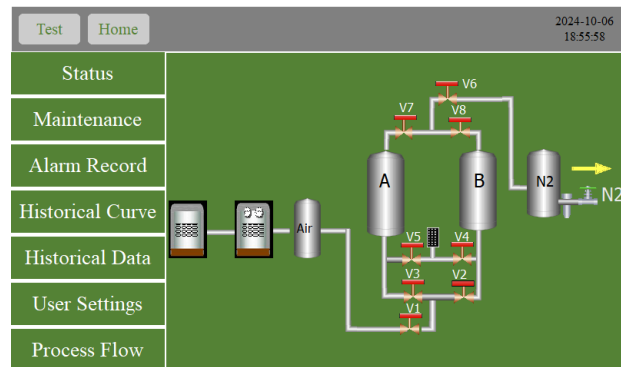

i. Test Screens

A factory password is required to access the “Test” screens. The factory password will only be provided to authorized personnel. The “Test” screens allow the timing sequence and sensor calibrations to be adjusted.

6. Maintenance

Proper maintenance will help ensure the maximum lifetime of the system with minimal down time. The time until the next scheduled maintenance is displayed on the “Maintenance” screen (section 5.c.). Preventative maintenance reminders will be programmed for six month intervals.

7. Troubleshooting/FAQ

Problem	Cause	Fix
PLC will not turn on	No/low power	Confirm power supplied is within specifications Ensure system is plugged in and breakers are on
System will not start	E-Stop is engaged	Turn the E-Stop button clockwise to deactivate it
Excessive noise	System leak or worn components	Schedule a service visit to replace worn components

8. Detail Drawings

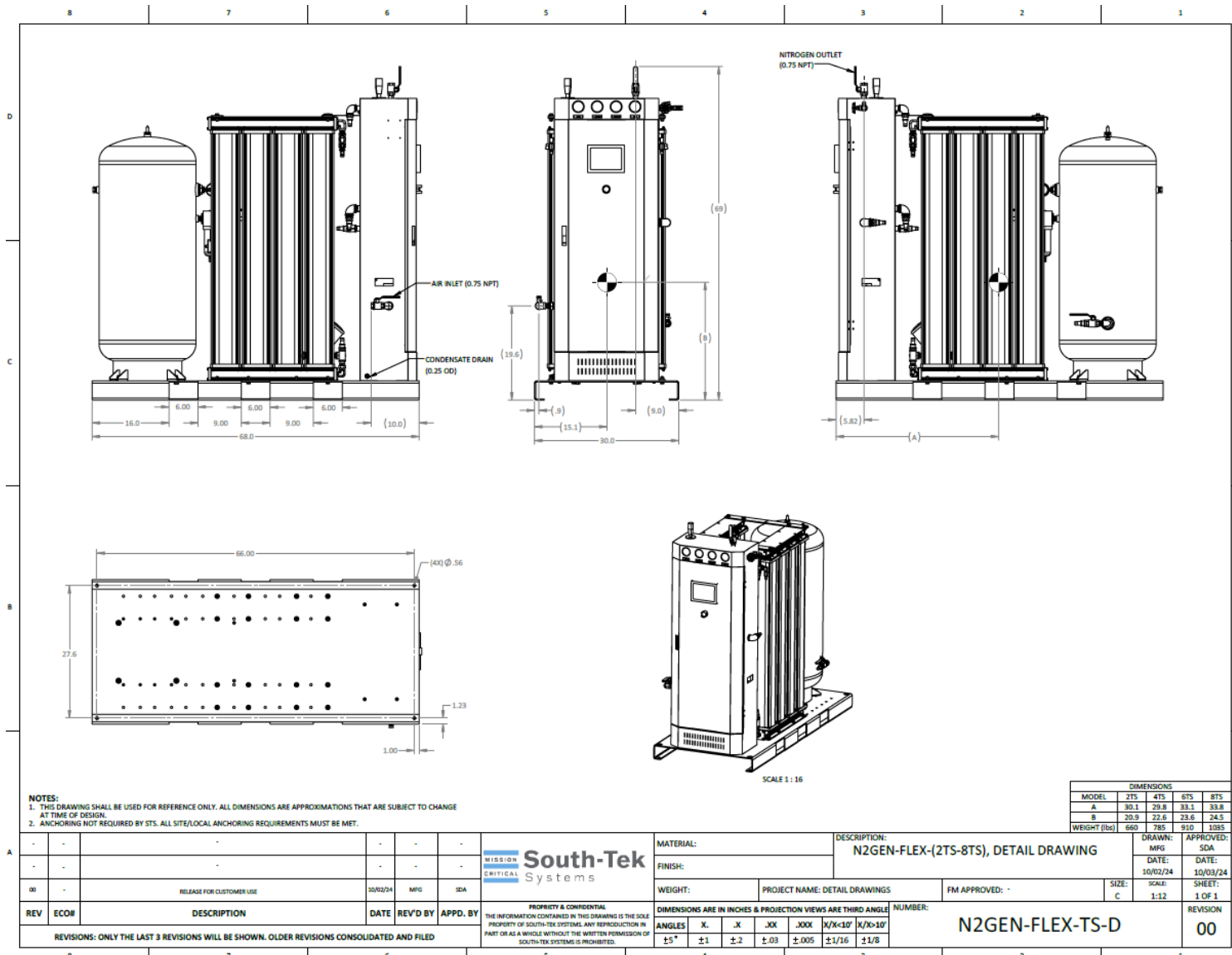

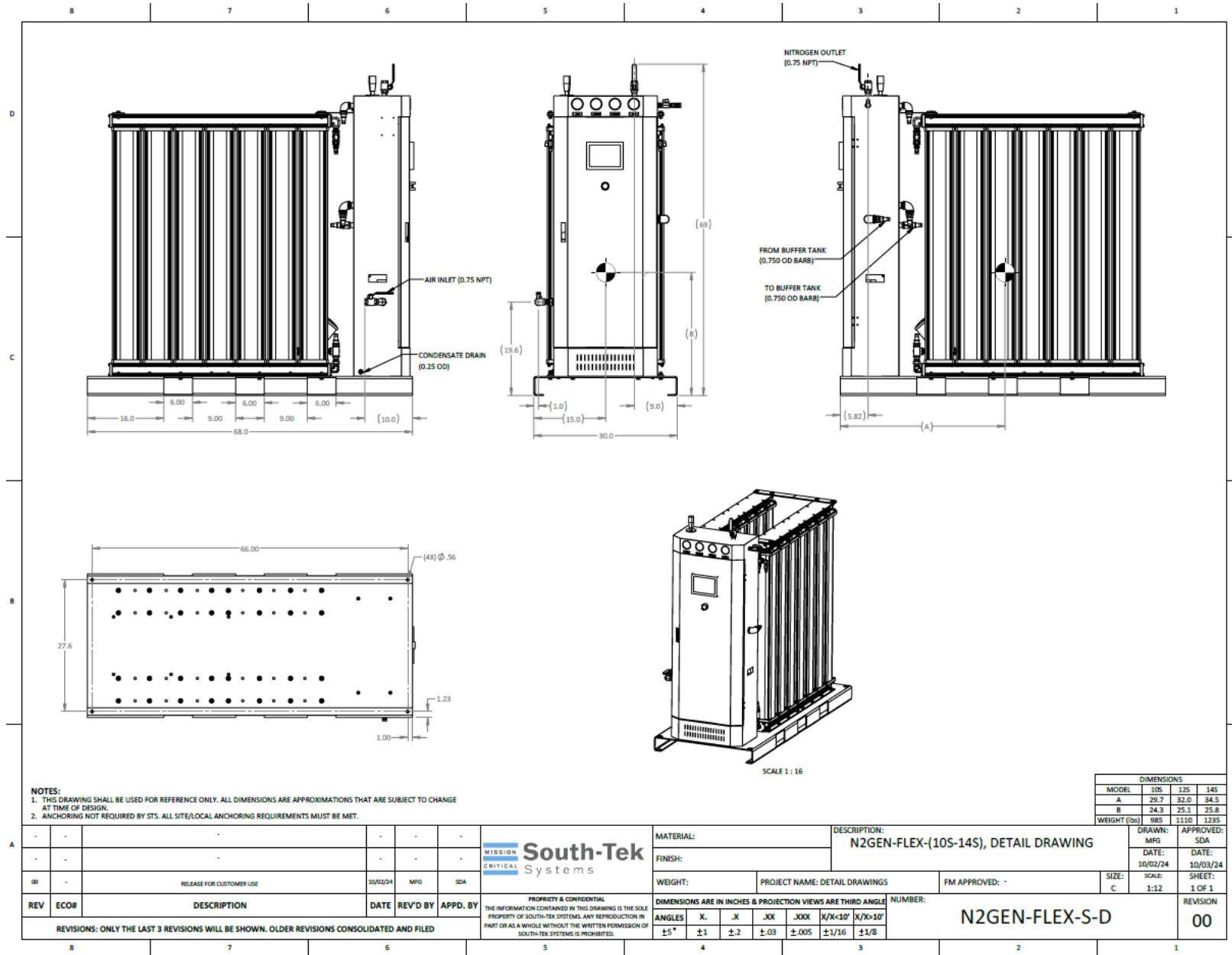

9. Disclaimer and Copyright

Disclaimer

The information provided in this product manual is intended for general guidance and informational purposes only. While we have made every effort to ensure the accuracy and completeness of the content, we cannot guarantee its absolute correctness or reliability. The use of the information contained herein is at the user's own risk. We shall not be held liable for any direct, indirect, incidental, consequential, or special damages arising out of or in connection with the use of this product manual.

Please note that this product manual may not cover all possible scenarios or variations of product usage. It is essential to exercise caution and refer to relevant local laws, regulations, and safety guidelines when using the product. We recommend consulting qualified professionals or contacting our customer support for specific inquiries or assistance.

Copyright

This product manual and all its contents, including text, images, diagrams, and illustrations, are protected by copyright laws and international treaties. All rights reserved. No part of this manual may be reproduced, distributed, or transmitted in any form or by any means, electronic or mechanical, including photocopying, recording, or any information storage and retrieval system, without prior written permission from the copyright holder.

The information contained in this product manual is confidential and proprietary to our company. Any unauthorized use or disclosure of this information may result in legal action.

Trademarks

All trademarks, service marks, logos, and product names mentioned in this manual are the property of their respective owners. The mention of any third-party trademarks does not imply endorsement or affiliation with our company, unless explicitly stated.

We reserve the right to make changes or improvements to the product specifications, functionality, or documentation without prior notice. While we strive to provide accurate and up-to-date information, we do not assume any obligation to update or correct any inaccuracies in this manual.

For any questions, concerns, or further information regarding this product manual, please contact our customer support team.



info@aservicios.mx
+52 (444) 818 9512
www.airtec-servicios.com